



FortiFone™ User Guide
for FON-475



FortiFone™ User Guide for FON-475

Revision 2

September 24, 2019

Copyright© 2019 Fortinet, Inc. All rights reserved. Fortinet®, FortiGate®, FortiCare® and FortiGuard®, and certain other marks are registered trademarks of Fortinet, Inc., in the U.S. and other jurisdictions, and other Fortinet names herein may also be registered and/or common law trademarks of Fortinet. All other product or company names may be trademarks of their respective owners. Performance and other metrics contained herein were attained in internal lab tests under ideal conditions, and actual performance and other results may vary. Network variables, different network environments and other conditions may affect performance results. Nothing herein represents any binding commitment by Fortinet, and Fortinet disclaims all warranties, whether express or implied, except to the extent Fortinet enters a binding written contract, signed by Fortinet's General Counsel, with a purchaser that expressly warrants that the identified product will perform according to certain expressly-identified performance metrics and, in such event, only the specific performance metrics expressly identified in such binding written contract shall be binding on Fortinet. For absolute clarity, any such warranty will be limited to performance in the same ideal conditions as in Fortinet's internal lab tests. In no event does Fortinet make any commitment related to future deliverables, features or development, and circumstances may change such that any forward-looking statements herein are not accurate. Fortinet disclaims in full any covenants, representations, and guarantees pursuant hereto, whether express or implied. Fortinet reserves the right to change, modify, transfer, or otherwise revise this publication without notice, and the most current version of the publication shall be applicable.

FortiVoice	fortivoice.com
Technical Documentation	docs.fortinet.com
Knowledge Base	kb.fortinet.com
Customer Service & Support	support.fortinet.com
Training Services	training.fortinet.com
FortiGuard	fortiguard.com
Document Feedback	techdocs@fortinet.com

Contents

Introduction 1

- Phone features 1
- Programmable keys 2
- Display layout 2

Installation 4

- Attaching the stand 4

Connecting the Phone 5

Setting up the Phone 6

- For use as an internal extension 6
- For use as an external extension 6

Personalizing your Phone 7

- How to navigate through menus 7
- Entering values with the dial pad and softkeys 7

Configuration Overview 8

Status 8

Features 8

- Call forward 8
- Auto answer 8
- Call waiting 8
- DND 8
- Intercom 8
- Ban anonymous call 9
- General 9
- Advanced 9

Application 10

- Memo 10
- Network toolkit 10

Directory	10
Local contacts	10
Adding a contact	10
Editing a contact	11
Deleting a contact	11
Searching a contact	11
Blacklist	11
Add a new contact to the Blacklist	11
Add an existing contact to the Blacklist	11
Whitelist	12
Add a new contact to the Whitelist	12
Cloud contacts	12
LDAP	12
History	12
Message	12
Basic settings	12
Language	12
Time & date	12
Screen	12
Ring	13
Voice volume	13
Bluetooth	13
Reboot system	13
Advanced settings	13
Accounts	13
Basic settings	13
Advanced settings	14
Network	14
Network	14
Security	16
Menu password	16
Keyboard password	16
Maintenance	16
Auto provision	16
TR069	16
Factory reset	16
Using your Phone	17
Receiving a call	17
Placing a call	17
Ending a call	19
Redial	19
Manually forward an incoming call	19

Hold	19
Mute	19
Attended transfer	19
Blind transfer	20
3-party conference	20
Call waiting	20
DND	20
Voicemail	20
Pairing/unpairing Bluetooth headset	21
Headset compatibility	21
Troubleshooting	23
Information	23
Troubleshooting guide	23
Character table to dial pad mode	24
Warranty	25



Introduction





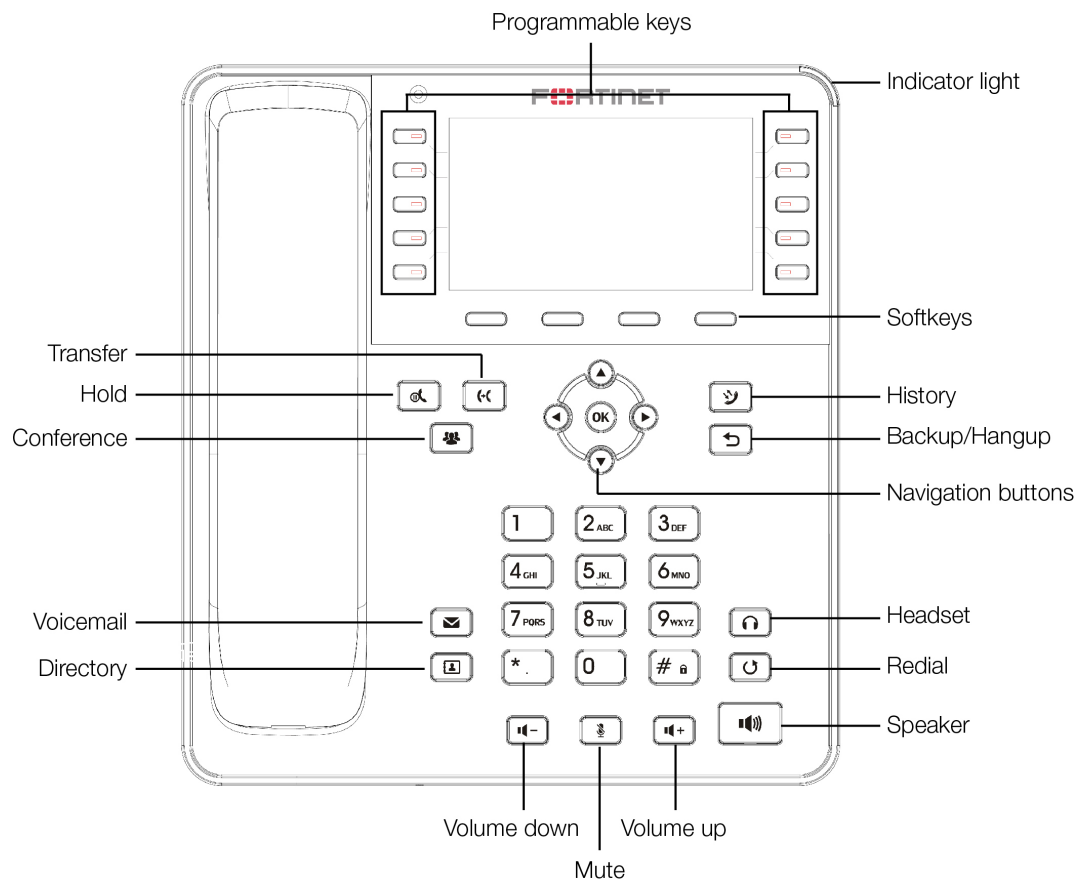







This user guide includes information about configuring and using your FON-475 IP phone.

Phone features

- 4.3" color display
- Dedicated feature keys
- 45 programmable keys
- Full duplex speakerphone
- 2x 10/100/1000 Mbps ports allow you to share the network connection with your computer
- PoE support eliminates the need for a power adapter



Button	Function
	Hold — places and retrieves calls on hold.
	Transfer — transfers calls to another extension or outside line.
	Conference — brings multiple calls together in a conference.



Button	Function
	Voicemail — accesses voicemail and voicemail greetings.
	Redial — places a call to the last number dialed.
	Mute — toggles the microphone on and off.
	Headset — toggles the headset on and off.
	Speakerphone — toggles the speaker on and off.
	Directory — accesses contacts stored on the phone.
	History — accesses the history of calls with this phone.
	Backup/Hangup — while in a menu, it will return to the previous menu. While on a call, it can be used as a hangup.
	Up arrow — navigates menu items. Displays the History if pressed on the main screen.
	Left arrow — navigates menu items. Navigates main screen icons such as Missed Calls, Voicemail and Do Not Disturb.
	Right arrow — navigates menu items. Navigates main screen icons such as Missed Calls, Voicemail and Do Not Disturb.
	Down arrow — navigates menu items. Displays the phone Status if pressed on the main screen.
	OK button — selects highlighted menu item.





Programmable keys

For information on how to configure the programmable keys, please consult the [FVE Admin Guide](http://www.fortivoice.com/support/documentation/index.html) located here: <http://www.fortivoice.com/support/documentation/index.html>.

Display layout

The phone has a 4.3" screen used to display information to the user, such as the extension name and number, time and date, as well as various status icons.

Icon	Description
	Network connected
	Network disconnected
	Call Forward enabled

Icon	Description
	Auto Answer enabled
	Keypad locked
	Missed call
	New voicemail
	Do Not Disturb disabled
	Do Not Disturb enabled
	Incoming call
	Handset mode
	Handsfree mode
	Headset mode
	Call on hold
	Microphone is muted

The bottom line shows choices associated with the four context-sensitive softkeys located just below the display.

Installation

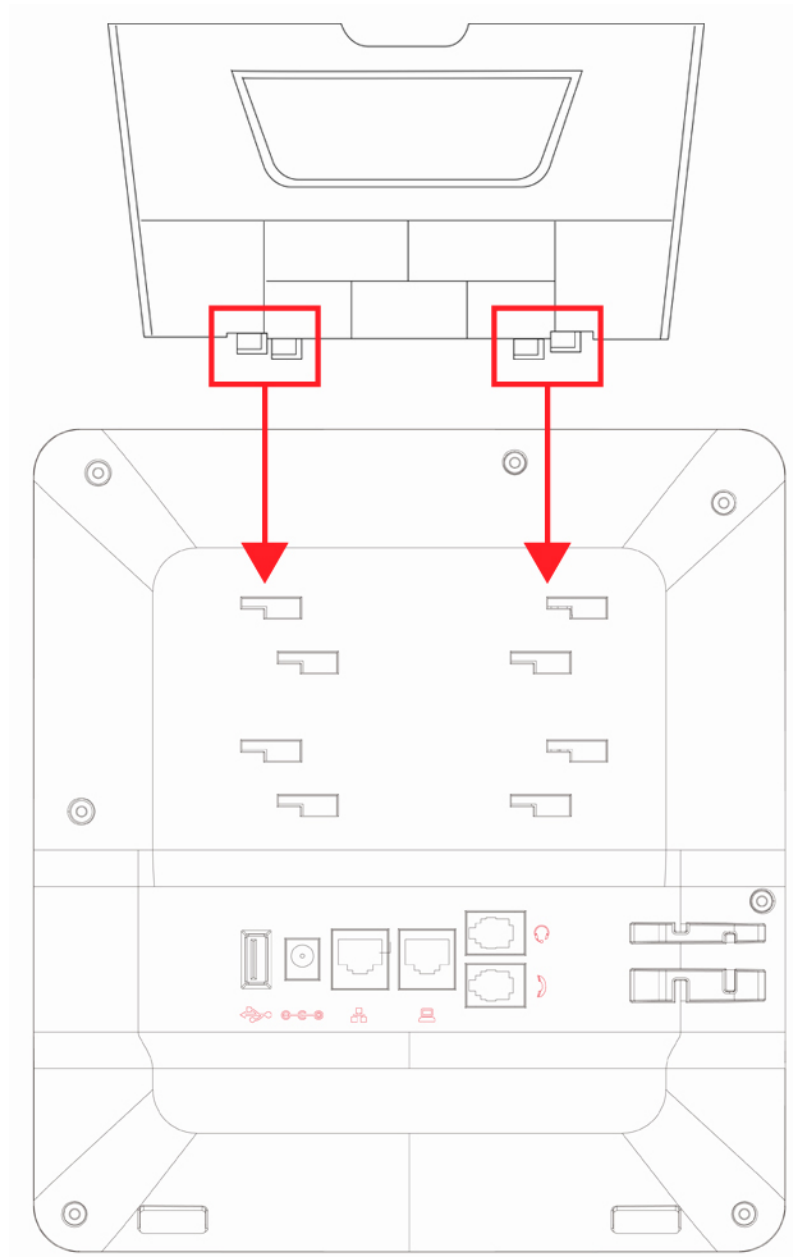

Attaching the stand

1. Line the four posts on the top of the base up with the four holes on the back of the phone, depending on the level of tilt you prefer.
2. Slide sideways into place until secure.

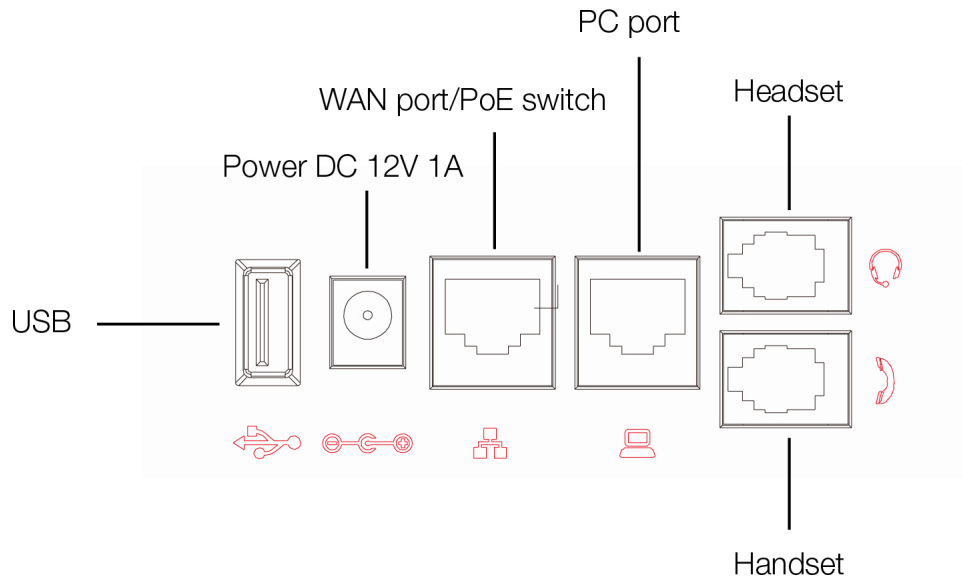

Connecting the Phone



1. Connect the handset cord to the handset and the  jack on the phone.
2. Optionally connect an amplified headset to the  jack.
3. Connect the WAN port to the network with the provided Ethernet cable.
4. Optionally, connect your desktop PC to the PC port with an Ethernet cable (not supplied).
5. If the network supports PoE, a power adapter is not required. The phone requires 5.7 W to function with PoE. If PoE is not supported on the network, connect the power adapter to the DC 12V 1A power jack.
6. The USB port is used for a Bluetooth CSR 4.0 dongle for use with Bluetooth headsets.

Setting up the Phone

For use as an internal extension

The phone supports plug and play installation and will automatically download its configuration from the FortiVoice system. The phone will display the extension number and name when it has registered.

Once configured within the FortiVoice system, reboot the phone to download its configuration and register to the system.

For use as an external extension

1. On the phone, press the Menu button.
2. Select Advanced.
3. Enter the password as 23646.
4. Select Maintenance.
5. Select Auto Provision.
6. Select Static Provisioning Server.
7. Set the Mode to After Reboot.
8. Press ▼ and set the Protocol to TFTP.
9. Press ▼ and set the Server as the public IP Address of the FortiVoice.
10. Press Save.
11. Now return to the Main Menu and select Basic > Reboot System.

Personalizing your Phone

How to navigate through menus

To access the configuration menu:

- Press the Menu softkey.

To select an item:

- Use the arrow keys to select an item, then press the OK button.

The bottom line of the display shows up to 4 softkey functions at a time. To return to a previous menu, press the Return softkey.

Entering values with the dial pad and softkeys

Use the dial pad to input numbers, letters, special characters, and a period. The dial pad mode is displayed above the second softkey as **123** for numeric, **ABC** for uppercase characters, **abc** for lowercase characters and **2aB** to be able to enter any of the characters.

To enter characters with the dial pad, use the digit with the desired character. Press the same digit repeatedly until the desired character appears in the LCD. After entering a character, pause to allow the cursor to move to next character position.

Other special entries include:

- To enter a period or dot (for example, to input an IP address), press **_** on the dial pad.
- To delete a letter in front of the cursor, press the Delete softkey.
- To enter special characters, press **A** on the dial pad while the mode softkey is set to **ABC** or **abc**.
- To enter a space, press **:** on the dial pad while the mode softkey is set to **ABC** or **abc**.

Prior to saving an entry, you may discard changes by pressing the Return softkey to move to the previous menu.

Configuration Overview

The phone supports the access and configuration of many parameters directly from the telephone user interface. To access the Configuration menu, press the Menu softkey while the phone is not in use.

The Configuration menu consists of several sub-menus as listed below:

- Status
- Features
- Application
- Directory
- History
- Message
- Basic settings
- Advanced settings

Status

The Status page includes information about the Network status, Phone status, Account status and TR069 status.

Features

The features here should be handled on the FortiVoice system and configured by the system administrator. Making changes to these features on the phone is not recommended.

Call forward

If enabled the phone can automatically forward calls to the programmed destination.

Auto answer

Enable or disable the Auto Answer feature. When the phone receives a call, it will automatically answer the call.

Call waiting

Enable or disable the Call Waiting tone.

DND

Enable or disable Do Not Disturb.

Intercom

Enable or disable the ability to receive intercom calls.

Ban anonymous call

Enable or disable the option to block calls that use Anonymous as the caller ID.

General

Contains a number of settings for how the phone operates:

- **Hide DTMF:** Enable or disable the option to hide DTMF digits from being displayed on the screen.
- **Ring From Headset:** Enable or disable ring tone heard on the headset.
- **Default Line:** If enabled, the default line to make outbound calls can be selected.
- **Auto Switch Line:** If enabled, the phone will choose the first available line when making an outbound call.
- **History:** Enable or disable retaining History records.
- **Ban Outgoing:** Enable or disable the ability to make calls from the phone.
- **Pre-Dial:** Enable or disable the option to Pre-Dial numbers. When enabled, the phone will not open an audio channel immediately while dialing a number.

Advanced

Contains a number of advanced settings for how the phone operates:

- **Dial Plan:** Enable or disable the option to hide DTMF digits from being displayed on the screen.
- **Dial Peer:** This feature can be used to make dialing longer numbers easier by creating rules for them. The following fields can be configured for creating dial rules:
 - Digit Map — Enter a dialing rule for matching numbers dialed. There are two types of matches; Full Match and Prefix Match. The Full Match will be triggered by the entire number being dialed and must match exactly. The Prefix Match uses a wild card of T. For

example; entering 9T here will trigger the dial rule when 9 is dialed, followed by any other number. Prefix Match will allow a maximum of 30 digits.

Apply to Call — Select the type of call to apply these settings to.

Match to Send — Select if a match is required to send the dialed number.

Line — Select which line to make the call on when a match is made.

Alias — This setting can replace a phone number, add numbers, delete numbers or replace specified characters. Enter these commands to take advantage of the Alias:

all: xxx — xxx will replace the phone number.

add: xxx — xxx will be dialed before the phone number.

del — the characters will be deleted from the phone number.

rep: xxx — xxx will be substituted for the specified characters.

Number — Enter the number to be dialed to trigger a match.

Suffix — Digits entered here will be added to the end of a matching phone number.

Length — Set the number of digits to be removed from the beginning of the matching phone number.

- Hotline: If enabled, configure a number to be dialed automatically when the handset or speaker are enabled.
- Password Dial: Enable or disable the option to hide a specific set of numbers. The Prefix is the number used to trigger hiding the number; the Length is how many numbers after the Prefix you would like to have hidden.
- EHS: Enable or disable electronic hookswitch for use with Plantronics headsets.

Application

Memo

Set a reminder on the phone that may alert you at the configured date & time.

Network toolkit

Ping the configured IP address from the phone to troubleshoot possible network issues.

Directory

Local contacts

The phone supports up to 1000 contacts. Each contact can have up to 3 phone numbers and a ring tone assigned. When a call is received from the contact, the specified ring tone overrides the default one.

Adding a contact

To add a contact:

1. Press the Add softkey.

2. Edit the following fields:
 - Name: name of the contact.
 - Office Number: phone number.
 - Mobile: mobile phone number.
 - Other Number: additional phone number field.
 - Line: select which line to use for this contact.
 - Ring Type: the ring tone that will be used when receiving calls from this contact.
 - Group: select the group that this contact will be a part of.

Editing a contact

To edit a contact:

1. Select a contact.
2. Press the Option softkey.
3. Select Edit, press OK.
4. Edit the information.
5. Press the OK softkey.

Deleting a contact

To delete a contact:

1. Select a contact.
2. Press the Option softkey.
3. Select Delete.
4. Press the OK softkey.

Searching a contact

To search for a contact:

1. Press the Search softkey.
2. Enter part of a number or name to search for.
3. Press the OK softkey.

Blacklist

Adding a contact to the Blacklist will prevent the contact from being able to call this extension.

Add a new contact to the Blacklist

1. Press the Add softkey.
2. Enter the Value, either the number or prefix.
3. Choose which Line to have the number or prefix blacklisted on.
4. Select the Type you would like to add: Number or Prefix.

Add an existing contact to the Blacklist

1. Press the Menu softkey.
2. Select Directory.
3. Select the Local Contact you would like to add to the blacklist.

4. Press the Option softkey.
5. Select Add to Blacklist.
6. Press the OK softkey.

Whitelist

Adding a contact to the Whitelist will prevent the contact from being blocked or added to the phone Blacklist.

Add a new contact to the Whitelist

1. Press the Add softkey.
2. Enter the Value, either the number or prefix.
3. Choose which Line to have the number or prefix blacklisted on.
4. Select the Type of call to allow the contact through.
5. Select the Type you would like to add: Number or Prefix.

Cloud contacts

The Cloud Phonebook is a list of contacts hosted by a server on the network.

LDAP

The LDAP settings allow for retrieving a contact list from an LDAP server.

History

The phone stores up to 300 calls in the Call Log, displaying inbound, outbound and missed calls.

Message

Access the voicemail associated with your extension.

Basic settings

Language

The phone supports many languages which can be selected here. This setting will only adjust the language on the screen of the phone, to change the audio prompts the language of the extension must be set within the FortiVoice.

Time & date

The time & date can be set to be obtained automatically or manually. The manual settings allows the user to change the Timezone, Location, set Daylight Saving Time, 12-hour Clock, Date, Time and the date Format.

Screen

The screen of the phone can be set to always be on or to dim after a specified period of time.

Ring

The Ring Volume can be changed here for both the handset and headset modes. The phone also supports different ring tones which can be set here under the Ring Type.

Voice volume

This setting allows the user to change the volume heard at the Handset, Handsfree speaker and Headset.

Bluetooth

When a compatible Bluetooth CSR 4.0 dongle is connected to the USB port of the phone, the Bluetooth feature may be enabled/disabled here.

Reboot system

Select to reboot the phone.

Advanced settings

The default password to enter the advanced settings is 23646.

Accounts

The Accounts section contains parameters to allow the phone to register to a SIP server or PBX. Contact your administrator before proceeding.

Basic settings

The following fields will be configured automatically through the FortiVoice. To make any changes to these settings contact the system administrator:

- Registration: enable or disable the account. Enabled accounts will try to register using the configured settings.
- Server Address: enter the IP address of the server to register with.
- Server Port: enter the port to register with the server on.
- Auth User: enter the authentication username for this account.
- Auth Password: enter the authentication password for this account.
- SIP User: the phone number or extension number of the account.
- Display Name: the caller ID that will be displayed when calling other phones. When connected to a FortiVoice system, the caller ID information will be configured in the web-based interface.
- Server Port: enter the port to register with the server on.
- Proxy Address: enter the IP address or FQDN of the outbound proxy.
- Proxy User: enter the username if required by the proxy server.
- Proxy Password: enter the password if required by the proxy server.
- Proxy Port: enter the port used to communicate with the proxy server.

Advanced settings

The following fields will be configured automatically through the FortiVoice. To make any changes to these settings contact the system administrator:

- Domain Realm: enter the Realm for the account.
- Dial Without Registered: enable or disable this feature to make calls through a proxy server when registration is not required.
- Anonymous: enable anonymous Caller ID using either RFC3323 or RFC3325.
- DTMF Mode: set the way that the phone sends DTMF.
- Use STUN: enable or disable the STUN setting.
- Sync Clock Time: enable or disable syncing time with server.
- Local Port: set the port that the phone will use for registration.
- Ring Type: change the ring tone that this particular account will use when receiving a call.
- MWI Number: enter the information needed for the phone to subscribe to a message waiting indicator.
- Pickup Number: enter the Pickup Number for the system.
- Park Number: enter the Park Number for the system.
- Join Call Number: enter the Join Call Number for the system.
- Missed Call Logs: enable or disable the option to show missed calls to this account.
- Feature Sync: enable or disable Feature Sync with the server.
- SCA: enable or disable Shared Call Appearance.

Network

Network

IP mode

Select the IP mode to use on the phone, IPv4, IPv6 or both.

IPv4 & IPv6 settings

Connection mode

The Connection Mode contains the options for how the phone will connect to the network:

- DHCP
- PPPoE
- Static IP

Static IP settings

The phone can be set up with a static IP address using these settings:

- IP Address
- Subnet Mask
- Gateway
- DNS1
- DNS2

DHCP settings

Enable or disable the phone from obtaining an IP address using DHCP.

PPPoE settings

Configure the Username and Password necessary to use PPPoE.

QoS & VLAN

The settings for QoS and VLAN can be enabled or disabled here:

- LLDP
- QoS
- WAN VLAN
- LAN VLAN
- CDP

Once a setting is enabled, press ▼ to view and configure the next setting.

VPN

Enable or disable and configure the VPN settings here.

Web server type

The Web Server Type can be set here as either HTTP or HTTPS.

Security

Menu password

The password to access the Advanced Settings can be changed here.

Keyboard password

Enables or disables the Keylock feature, which will lock the dialpad and require a password to unlock. The password to unlock the dialpad is 123.

Maintenance

Auto provision

IPv4 & IPv6 DHCP option

Set the DHCP Option to use to automatically provision the phone:

- Option 43
- Option 66
- Custom 128–254 (if selected, press ▼ to enter the value for this option)
- Disabled

SIP Plug and Play

Enable or disable the SIP Plug and Play options

Static Provisioning Server

Enable or disable the use of a Static Provisioning Server.

TR069

Settings

Enable or disable the use of TR069.

Status

If TR069 has been configured, this section will display status updates.



Factory reset

This will default all of the settings on the phone.

Using your Phone

Receiving a call

When you receive a call, the phone will display the call details and the ring indicator will flash. The phone will also ring unless the ringer is off.

- To answer the call with the handset, lift the handset.
- To answer the call with the speakerphone, press  or the Answer softkey.
- To answer the call with the headset, press .

If your extension has call waiting enabled, you can press the Answer softkey to answer the second call.

To reject a call, press the Reject softkey. The call will follow the extension's busy settings as configured in the Call Handling section.

Placing a call

You can place a call by dialing a number, selecting a number from the call log or a contact from the phonebook.

To dial an extension number:

1. Dial the extension number.
2. After about 4 seconds, the phone will dial the number.
3. Optionally, press OK, the Send softkey or ? to place the call immediately.

To dial an outside number:

1. To access an outside line, dial the outgoing access code (for example: L or :) if configured within the Fortivoice.
2. Dial the phone number.
3. After about 4 seconds, the phone will dial the number.
4. Optionally, press OK, the Send softkey or ? to place the call immediately.

To dial a number from the History:

1. Press the History softkey.
2. Select a History entry. Press the Dial softkey.



To dial a number from the Directory:

1. Press the Directory softkey.
2. Select the Directory option you would like to dial from.
3. Select a contact to dial.
4. Press the Dial softkey.

By default, all calls will use the speakerphone. Lift the handset if you wish to place a call using the handset. Press  if you wish to place a call using the headset.



Ending a call

To end a call:

- Press the End softkey
- If you are using the handset, place it in the cradle.
- If you are on speakerphone, press .
- If you are using a headset, press .

Redial

Allows you to redial the last number dialed:

1. Press . The phone activates the speakerphone and places the call.
2. You can also lift the handset or press  followed by pressing .

Manually forward an incoming call

While the phone is ringing, the call may be diverted to another extension without answering.

To divert a call:

1. Press the Forward softkey.
2. Enter the extension number to Forward the call to.
3. Press the Dial softkey.



Hold

To place calls on hold, press the Hold softkey. While a call is on hold, you can answer or place other calls. The held party will hear music, if configured to do so on the FortiVoice.

To toggle between two calls, use the navigation keys and press the Answer or Resume softkey.

Mute

Mute turns the phone's microphone on or off.

1. Press  to disable the microphone. The mute button will turn red.
2. Press  again to enable the microphone. The mute button will no longer be lit.

Attended transfer

Calls can be announced to the party receiving the transfer before completing the transfer.

To perform an attended transfer:

1. Press the Xfer softkey.
2. Dial the extension or phone number then press the Dial softkey.
3. Announce the call.
4. Press the Xfer softkey.

Blind transfer

Calls can be transferred without talking to the party receiving the transfer.

To perform a blind transfer:

1. Press the Xfer softkey.
2. Dial the extension or phone number.
3. Press the Xfer softkey.

3-party conference

The phone supports conferencing with two other parties.

To create a 3-party conference:

1. Place the first call.
2. Press the Conference softkey. The first call will be placed on hold.
3. Call the second party for the conference.
4. When the second party answers, press the Conference softkey again.

To end a conference call:

1. Press the Split softkey to separate the parties from the conference.
2. Press the End softkey to end the conference call. Both parties will be disconnected.

Call waiting

When Call Waiting is enabled, the phone will present new calls to you while you're on a call. In order to use call waiting, it will first need to be enabled in the FortiVoice interface.

To answer an incoming call while on a call, press the Answer softkey. The initial call will be placed on hold. Refer to the “Hold” section on how to toggle between calls.

DND

When DND (Do Not Disturb) is enabled, you will not be notified of incoming calls.

1. Press the DND softkey to enable DND.  will be displayed.
2. Press the DND softkey again to disable DND.

Voicemail

When you have a message waiting, the message indicator flashes and  appears to indicate you have new messages in your mailbox.

To access your voice mailbox:

- Press  or use the navigation arrows to select the voicemail icon and press the OK button.

Pairing/unpairing Bluetooth headset

When a compatible Bluetooth CSR 4.0 dongle is connected to the USB port, Bluetooth is automatically enabled under Basic settings.

To pair a supported Bluetooth headset:

1. Power on the Bluetooth headset and initiate its “Pairing” mode (see the headset manufacturer’s user guide).
2. On the phone, press the Menu softkey.
3. Select Basic.
4. Select Bluetooth.
5. Press the Enter softkey.
6. Press the Scan softkey to scan for the Bluetooth device.
7. After a few seconds, the Bluetooth device will appear on the screen.
8. Select the Bluetooth device and press the Connect softkey.
9. The Bluetooth headset will indicate that it is paired. The phone’s screen will also show a Bluetooth icon indicating Bluetooth connectivity.

To unpair the Bluetooth headset:

1. Tap Menu.
2. Tap Basic.
3. Tap Bluetooth.
4. Tap the connected Bluetooth device. A successful disconnection message will appear.

Headset compatibility

The following table shows the Bluetooth headset vendors and models that are compatible with FON-475.

Vendor	Model
Plantronics	Voyager 5200
	Discovery 975
Jabra	Boost
	Evolve 65
	Evolve 75
	Evolve 75e
	Stealth
	Motion
	Speak 710
Sennheiser	Presence
	MB Pro1
	MB Pro2
Vbet	VT9600BT
JOWAY	H-02

Vendor	Model
QCY	J02S
Xiaomi	Youth
Masentek	M26

Troubleshooting

Information

Pressing ▼ on the phone provides the means to quickly view the network parameters (IP address, default gateway address, and subnet-mask), registration status of phone, MAC address and firmware version. This information may be useful if calling Fortinet Support.

Troubleshooting guide

Symptoms	Corrective actions
Display is blank	Confirm the phone's power source. <ol style="list-style-type: none">If you are using the power adapter:<ul style="list-style-type: none">Ensure it is plugged in. If it still doesn't work, replace the power adapter.If you are using Power over Ethernet (PoE):<ul style="list-style-type: none">Ensure your Ethernet cable is plugged into the INTERNET port on the back of your phone.Ensure the PoE switch is properly configured. If it still doesn't work, replace the Ethernet cable.
Phone not obtaining an IP address	The DHCP server is not responding. <ol style="list-style-type: none">Ensure your DHCP server is online. This is typically your router.Reboot the router or DHCP server.If you are still experiencing issues, the phone may require advanced network configuration. Contact your administrator.
Phone will not register	Your phone is not registered. <ol style="list-style-type: none">On the Extension page of the FortiVoice interface, ensure the MAC address is correctly entered and the Phone Type is FON-475. Save your configuration and reboot the phone.On the phone, ensure the TFTP IP address is correct. To verify, see "For use as an external extension" on page 6.If your phone is configured as an external extension, check the network connection and firewall settings at the phone system location.
No audio during a call	<ol style="list-style-type: none">Check the handset/headset connections.Make sure the phone is properly registered with the phone system.If your phone is configured as an external extension, check the network connection and firewall settings at the phone system location.

Character table to dial pad mode

Digit	Dial Pad Mode			
	abc	ABC	2aB	123
1			1	1
2	abc	ABC	2 a b c A B C	2
3	def	DEF	3 d e f D E F	3
4	ghi	GHI	4 g h i G H I	4
5	jkl	JKL	5 j k l J K L	5
6	mno	MNO	6 m n o M N O	6
7	pqrs	PQRS	7 p q r s P Q R S	7
8	tuv	TUV	8 t u v T U V	8
9	wxyz	WXYZ	9 w x y z W X Y Z	9
0	Space	Space	0 Space	0
*	.,*/+:-: _ =	.,*/+:-: _ =	*	*
#	#^!&,\$%	#^!&,\$%	#	#

Warranty

This phone is covered by a one-year hardware warranty against manufacturing defects as set forth in the EULA.

www.fortivoice.com/support

For warranty service:

- In North America, please call 1-866-648-4638 for further information.
- Outside North America, contact your sales representative for return instructions.

You will be responsible for shipping charges, if any. When you return this telephone for warranty service, you must present proof of purchase.

